



SLHC-PP

DELIVERABLE REPORT

EU DELIVERABLE: 2.2.1

Document identifier:	SLHC-PP-D2.2.1-982408-v1.0
Contractual Date of Delivery to the EC	End of Month 12 (March 2009)
Actual Date of Delivery to the EC	30/3/2009
Document date:	16/02/2009
Deliverable Title:	Functioning collaboration communication structure
Work package:	WP2: Coordination for the sLHC accelerator implementation
Lead Beneficiary:	CERN
Authors:	Gijs DE RIJK
Document status:	Released
Document link:	https://edms.cern.ch/document/982408/1



DELIVERABLE REPORT

Doc. Identifier:
SLHC-PP-D2.2.1-982408-v1.0

Date: 16/02/2009

History of Changes

Version	Date	Comment	Authors
1.0	17-02-09	First draft	G. de Rijk

Copyright notice:

Copyright © Members of the SLHC-PP Collaboration, 2009.

For more information on SLHC-PP, its partners and contributors please see www.cern.ch/SLHC-PP/

The Preparatory Phase of the Large Hadron Collider upgrade (SLHC-PP) is a project co-funded by the European Commission in its 7th Framework Programme under the Grant Agreement n° 212114. SLHC-PP began in April 2008 and will run for 3 years.

The information contained in this document reflects only the author's views and the Community is not liable for any use that may be made of the information contained therein.



TABLE OF CONTENTS

1. EXECUTIVE SUMMARY 4

2. LHC LUMINOSITY UPGRADE 4

3. SLHC ACCELERATOR PROJECT STRUCTURE 5

 3.1. SLHC SUB-PROJECTS..... 6

4. LINAC4 7

5. INNER TRIPLET PHASE 1 9

6. SPL 11

7. PS2 12

8. SPS UPGRADE STUDIES 14

9. LUMINOSITY UPGRADE NETWORK 14

10. CONCLUSIONS 14

1. EXECUTIVE SUMMARY

The current LHC configuration is set up to produce proton–proton collisions at a centre-of-mass energy of 14 TeV and a luminosity of up to $10^{34} \text{ cm}^{-2}\text{s}^{-1}$. The sLHC project (super LHC), however, aims for a tenfold increase in luminosity for 14 TeV proton–proton collisions, achieved through the successive implementation of several new elements and technical improvements that are scheduled for 2013–2018. These include the major replacement of several accelerators in the LHC proton-injector chain, upgrades of the LHC interaction regions and enhancements to the general-purpose experiments ATLAS and CMS. The accelerator part of the sLHC project consists of a set of sub-projects that fall into three categories: sLHC construction projects, sLHC project preparation studies and an sLHC luminosity upgrade network. The construction projects have been approved and the project execution has started. This part of sLHC is also indicated as Phase 1. Phase 1 is to become operational in 2013-2014. The sLHC project preparation studies are preparing a proposal for approval by the CERN Council in 2011-2012 and will, if approved, be transformed in construction projects that should be completed by 2017-2018. The sLHC luminosity network studies the options for further upgrades to be implemented after 2017. The sLHC project is led by a project leader who is assisted by a project office in the CERN accelerator sector.

2. LHC LUMINOSITY UPGRADE

The sLHC (super-LHC) is luminosity upgrade of the existing LHC. The program for the upgrade is spread over all machines in the LHC injector chain and the LHC itself. From the formula of the luminosity of a proton-proton collider one can very swiftly see which are the key parameters for an upgrade. The identification of these parameters in the accelerator chain is then straightforward.

The luminosity is given by:

$$L = \frac{N_b^2 n_b f_r \gamma}{4\pi \varepsilon_n \beta^*} F$$

with: N_b number of particles per bunch
 n_b number of bunches
 f_r revolution frequency
 γ relativistic gamma factor
 ε_n normalized emittance
 β^* Beta value at the interaction point
 F reduction factor due to crossing angle

The quantities that are subject to improvement and resulting upgrade location are:

$N_b, \varepsilon_n \Rightarrow$ injector chain
 $\beta^* \Rightarrow$ LHC insertion
 $n_b \Rightarrow$ electron cloud effect
 $F \Rightarrow$ beam separation scheme

The resulting upgrade plan consists of improving the injector chain, upgrading the low- β insertions, reducing the electron cloud effect in the SPS and changing the beam separation scheme in the LHC. These upgrade projects are spread over a 10 year period and are the essence of the sLHC project.

3. SLHC ACCELERATOR PROJECT STRUCTURE

The sLHC project consists of a set of sub-projects that fall into three categories: sLHC construction projects, sLHC project preparation studies and an sLHC luminosity upgrade network. A schematic view of the upgrades scenario for the LHC injector complex can be found in Figure 1. In Figure 2 an aerial view can be found with the new injector accelerators drawn on top of it.

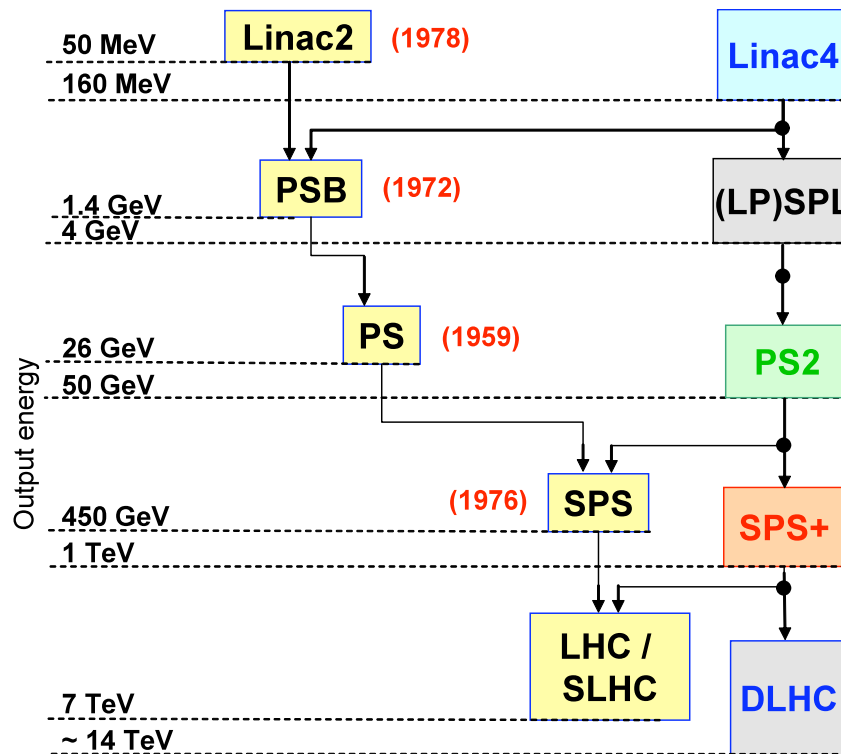

Figure 1. sLHC upgrade scenarios

In order to cope with a series of upgrades or replacement of the existing CERN injector accelerator complex without interrupting operations, the machines will be upgraded in the sequence indicated in Figure 1. This sequence also dictates the structure of the project. The options SPS+ and DLHC are still speculative, but have been added for completeness.

The upgrade projects inside the LHC ring (e.g. Inner Triplet Phase 1) are done in parallel to the work on the injectors. The planning of sLHC requires that the long shut down periods that will be needed to replace the connecting equipment in the injectors and the inner triplets in the LHC ring will have to coincide, so that a minimum of physics running time is lost on interventions. These long shutdown periods are planned in 2 periods 2013-2014 and 2017-2018.

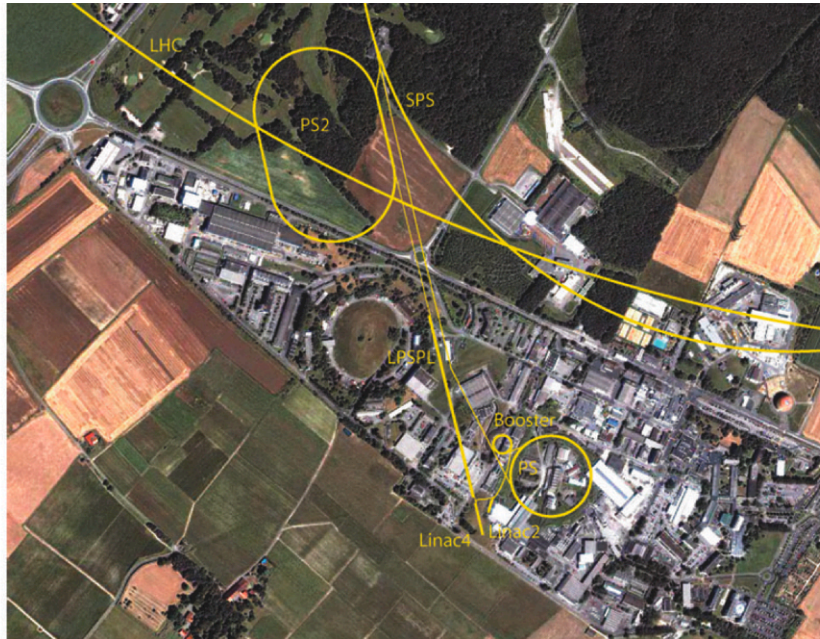

Figure 2. Aerial picture with the old and new injectors superimposed

3.1. SLHC SUB-PROJECTS

Below a short technical description of each of the sub-projects is given. In sections 4 to 9 the organization of each sub-project is described.

Two sLHC construction projects:

They address the most urgent issues in the injector chain and in the LHC insertions

1. Linac4.

The first bottleneck in the present layout occurs with the injection of proton bunches from Linac2 into the Booster. Protons are injected at 50 MeV by a multiturn injection process that inherently dilutes the beam brightness (the current within a given emittance). Much can be gained from using H^- particles in the linac followed by injection in the Booster using a charge-exchange technique that removes excess electrons. This method avoids a dilution of beam brightness and directly translates into a luminosity increase in the LHC. Capturing and accelerating the now more brilliant beam requires an energy increase in the linac, thus reducing the beam self-repulsion in the Booster. This justifies the present 50 MeV proton linac (Linac2) being replaced by a new 160 MeV linac (Linac4) operated with H^- ions. Secondly to the performance argument, the existing Linac2 is displaying worrying wear symptoms and should be replaced within the next 5 years.

2. Inner triplet Phase 1.

Lowering the β^* value in the interaction areas from 0.55 m to 0.25 m gives potentially a direct luminosity increase of a factor two. The limiting parameter at the moment is not the strength of the low- β quadrupoles but their aperture. At such low β^* values the maximum size of the beam would be too large for the existing magnets. The new insertion quadrupoles will have a coil aperture of 120 mm, while the existing quadrupoles have a coil aperture of 70 mm.

Three sLHC project preparation studies:

1. SPL

The injector machine for the PS2 will have a top energy of 4 GeV, in order to sufficiently reduce the intensity limiting space charge effects in the PS2. The machine will take the beam from Linac4 at 160 MeV and accelerate it in a superconducting linac up to 4 GeV. The SPL will be constructed in two phases. The first phase, L(ow)P(ower)-SPL (0.19 MW) will be optimized for LHC beams. An optional second phase will be to upgrade the SPL to a high power (3-9MW) 5 GeV machine (HP-SPL) for a possible future neutrino facility.

2. PS2

The existing PS machine accelerates protons, intended for the LHC, from 1.4 GeV up to 26 GeV for injection into the SPS. The PS machine was commissioned in 1959 and despite the latest campaign of consolidation it has a finite lifetime. Before the end of the next decade the machine will have to be replaced. The PS is a combined function machine of a design typical for the 1950-ies. Over the last 5 decades its performance (intensity, emittance, particle types, etc.) has been upgraded well over the design values and the possibilities for further improvements are coming to an end. It is becoming urgent to design a new machine to replace the PS. In order to overcome the present injection intensity limits in the SPS the PS2 extraction energy will be 50 GeV.

3. SPS upgrade

The SPS experiences several intensity limitations (electron cloud, impedance, space charge at injection, injection aperture). Before a program can be started to 'cure' the limitations a thorough understanding of the effects is needed. To this aim an extensive measurement campaign on key SPS parameters is currently carried out.

One sLHC luminosity upgrade network:

Previously CARE-HHH (see also: <http://care-hhh.web.cern.ch/care-hhh/>), the network is now EuCARD-AccNet-EuroLumi. This network studies all the LHC luminosity upgrade options and is the 'spawning site' for new sLHC sub-projects. Two major study subjects are the interaction region layout for a phase 2 upgrade and the collimation requirements for phase 2.

4. LINAC4

The Linac4 project started officially in 2008. Civil engineering started with a groundbreaking ceremony on the 22nd October 2008. A picture of the Linac4 implementation into the CERN site can be found in Figure 3. The master planning of this project can be found in Figure 4. The project is described on its web site: <http://linac4.web.cern.ch/linac4/> . The development of Linac4 accelerator components was started several years ago in the CARE-HIPPI framework with:

- Development and prototyping of the Linac4 accelerating structures,
- Design and construction of the chopper structure and of the chopper line,
- Development of the beam optics, benchmarking of codes,
- Development of specific diagnostics.

The development was done in contact (exchange of information and expertise) with other institutes, with the support of an External Advisory Committee and co-financed by the EC FP6 program and the participating institutes (see: <http://mgt-hippi.web.cern.ch/mgt-hippi/>).

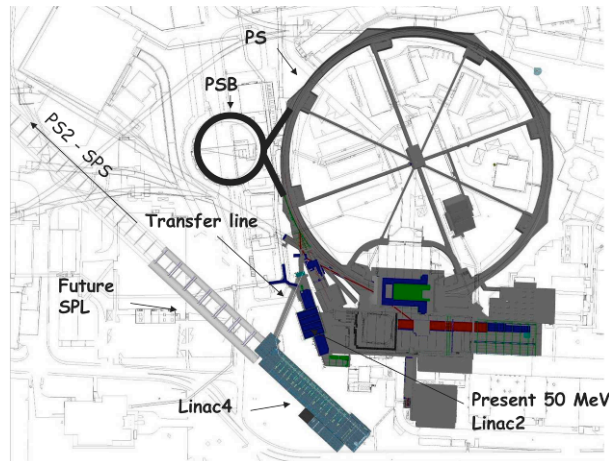

Figure 3. Linac4 on the CERN site

LINAC4 MASTER PLAN – 30.10.2007

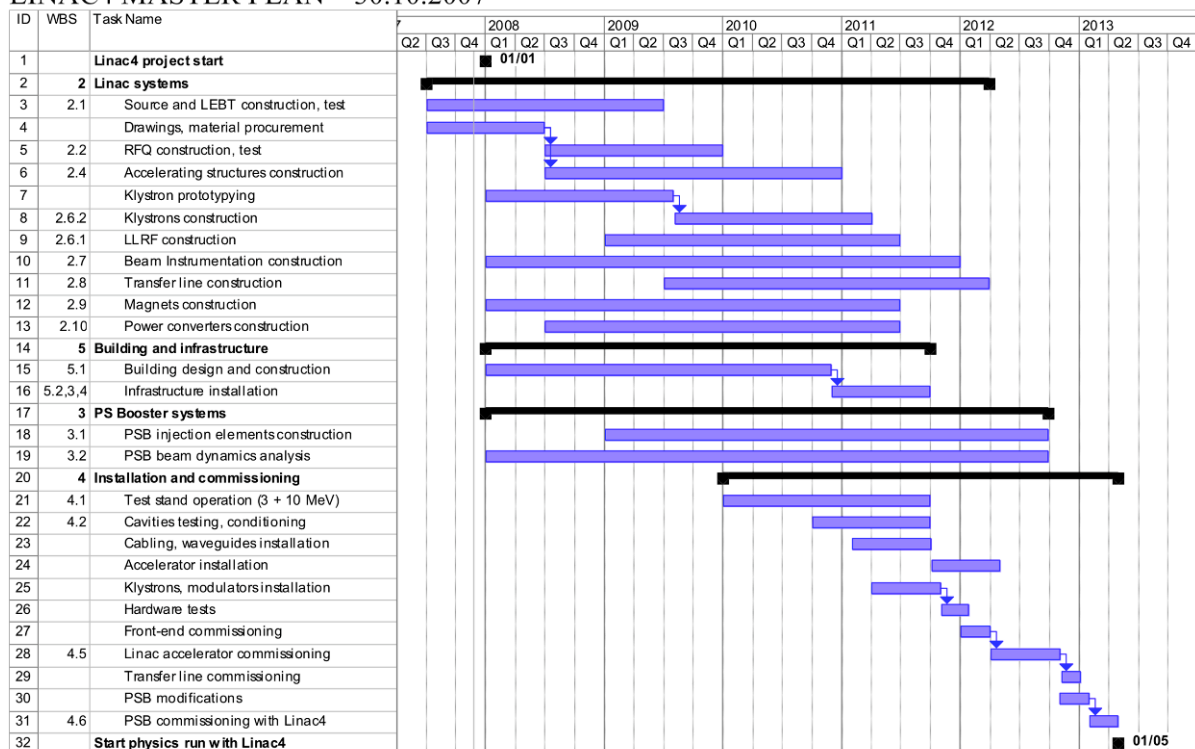
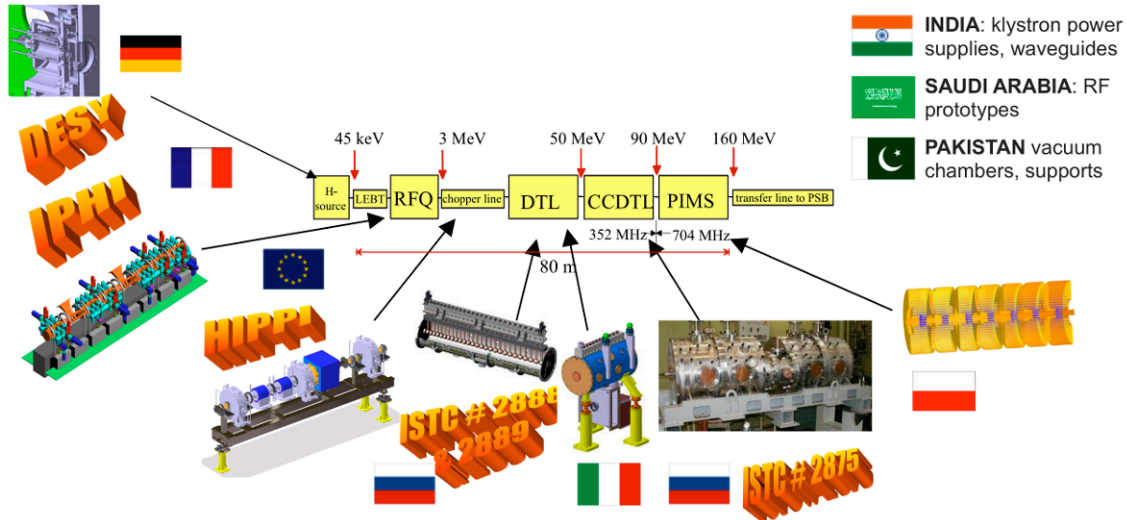

Figure 4. Master planning of Linac 4

The Linac4 collaboration comprises institutes in the CERN member states and also several non-member states. A summary of the collaboration is given in Figure 5. Several large

contracts are under negotiation with the partners. The description of the work in terms of work-packages is finalized, the complete project is entered in the E(arned) V(alue) M(anagement) system at CERN and a hardware baseline is defined.



Network of collaborations for the R&D phase, via EU-FP6, CERN-CEA/IN2P3, ISTC (CERN-Russia), CERN-India and CERN-Pakistan agreements.

International participations to the construction of Linac4 **under definition**:

Signed or being signed: **Russia** (CCDTL), **France** (modulators, etc.), **Pakistan** (transfer line)
In preparation: **Saudi Arabia** (DTL tanks), **Poland** (PIMS), **India** (supports, waveguides, 16 couplers, etc.), **USA** (diagnostics).

Figure 5. The Linac4 collaboration

5. INNER TRIPLET PHASE 1

Goal of the Inner Triplet Phase 1 upgrade is: To enable focusing of the beams to $\beta^* = 0.25$ m in IP1 and IP5, and reliable operation of the LHC at 2 to $3 \cdot 10^{34} \text{ cm}^{-2} \text{ s}^{-1}$ on the horizon of the physics run in 2014.

The scope of the project can be listed in the following 5 points:

- To upgrade of ATLAS and CMS interaction regions. The interfaces between the LHC and the experiments will remain unchanged.
- To replace the present triplets with wide aperture quadrupoles based on the LHC dipole (Nb-Ti) cables cooled at 1.9 K.
- To upgrade the D1 separation dipoles, TAS and other beam-line equipment so as to be compatible with the inner triplets.
- To modify matching sections to improve optics flexibility, machine protection and introduce other equipment relevant for luminosity increase to the extent of available resources.
- The cryogenic cooling capacity and other infrastructure in IR1 and IR5 remain unchanged and will be used to the full potential.

In Figure 6 two layouts of the interaction regions can be found, the present layout is shown compared to the new upgraded one. The project preparation started in the end of 2006 and the project was operational in January 2008. The inner triplet project organization is finalized and the collaborations are defined. In Figure 7 the collaboration structure for the Inner Triplet project can be found. The description of the work in terms of work-packages is finalized, the complete project is entered in the E(arned) V(alue) M(angement) system at CERN and a hardware baseline is defined (see: <http://slhc-irp1.web.cern.ch/sLHC-IRP1/>). The installation is foreseen for the shutdown period of 2014.

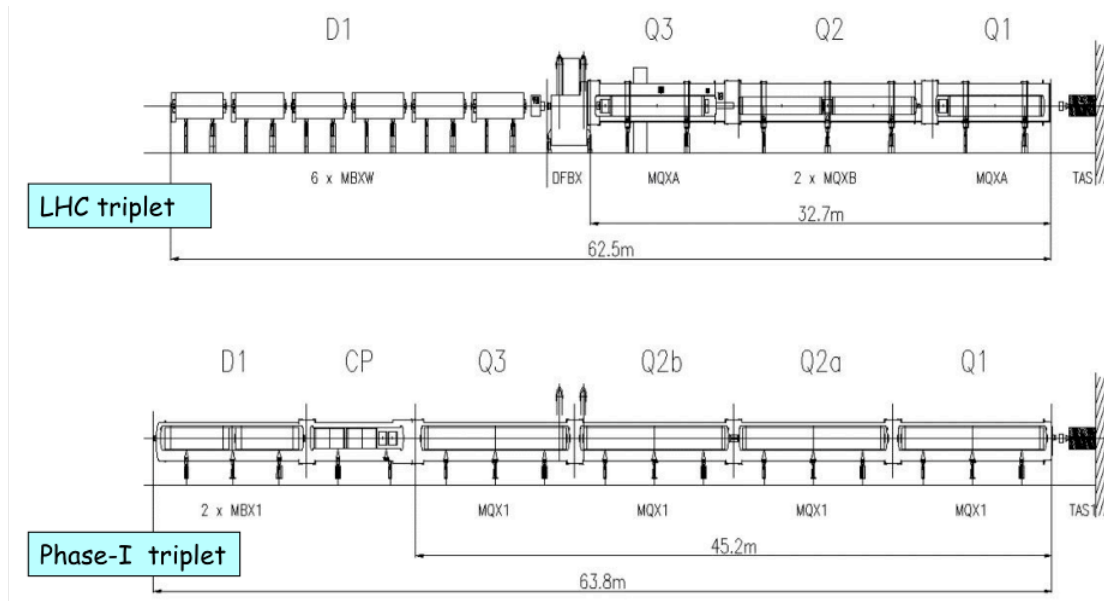

Figure 6. Inner Triplet Phase 1 upgrade, layout of old and new triplet

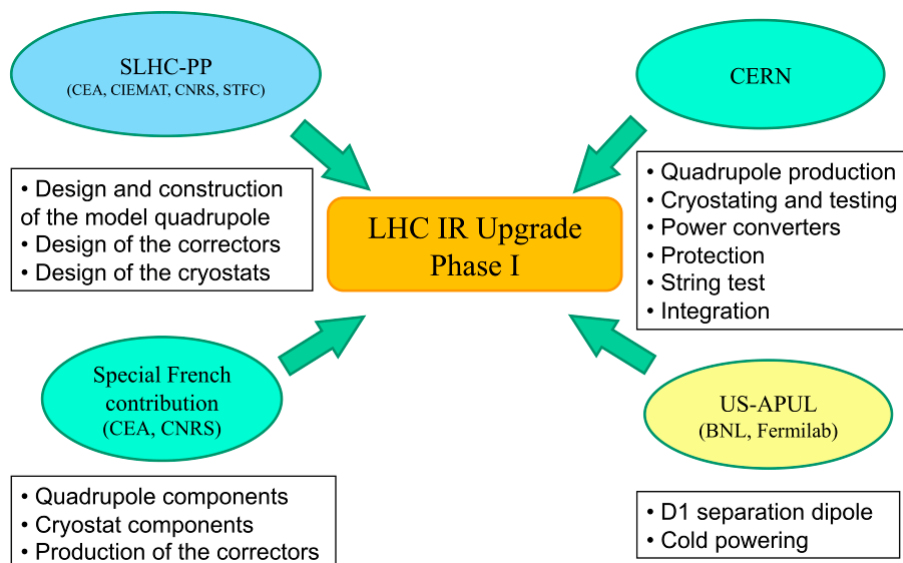

Figure 7. Inner Triplet Phase1 collaboration structure

6. SPL

The initial ideas for the SPL have been launched in 2000. A conceptual design report for SPL was produced in 2006 (http://doc.cern.ch/yellowrep/2006/2006-006/full_document.pdf). A site decision has been taken in 2007 in conjunction with the approval of Linac4 and the site selection for PS2. The SPL study project is preparing for presentation to the CERN Council by 2012 for a decision on the construction. A schematic layout of the LP-SPL machine can be found in Figure 10.

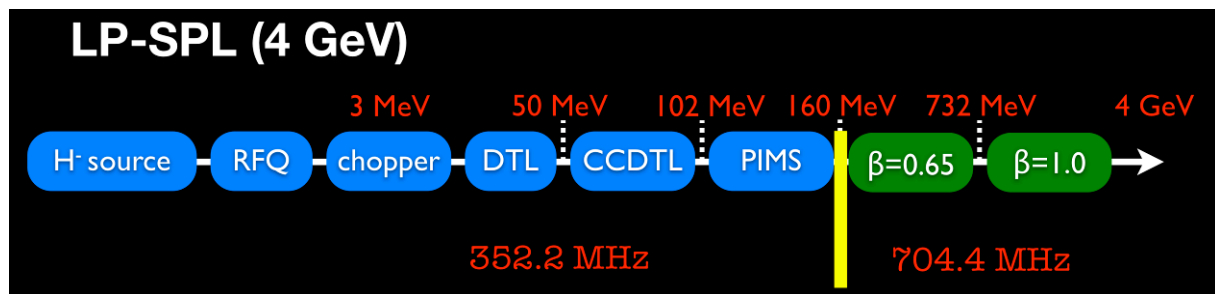

Figure 10 Schematic layout of LP-SPL

In Table 1 a summary can be found of the existing collaboration agreements for SPL. The collaboration subjects that are still under negotiation are listed in Table 2.

Table 1. SPL existing collaboration agreements

Institute	Subject
CEA Saclay (France)	<ul style="list-style-type: none"> Design and construction of 2 $\beta=1$ cavities (EUCARD task 10.2.2), Helium vessels for 2 cavities & tools for cryomodule assembly (French in-kind contribution), Test of existing $\beta=0.5$ cavity in pulsed mode and participation to LLRF design (CNI sLHC)
CNRS/IPN Orsay (France)	<ul style="list-style-type: none"> Design and construction of $\beta=0.65$ cavity (EUCARD task 10.2.1), Design and construction of prototype cryomodule (French in-kind contribution)
Soltan Institute (Poland)	<ul style="list-style-type: none"> FLUKA simulations for radiation protection issues, collimator development,
ESS-S (Scandinavia)	<ul style="list-style-type: none"> beam dynamics, RF developments,
Cockroft Institute (UK)	<ul style="list-style-type: none"> participation to specification & design of RF system, study of RF components (RF power distribution, vector modulators, phase-locked magnetrons), study & design of low-power collimation systems

Table 2. SPL collaboration agreements under negotiation

Institute	Subject
ESS-Bilbao (Spain)	• Design and construction of 50 Hz klystron modulator,
ESS-Debrecen (Hungary)	..to be defined
Rostock University (Germany)	• HOM damper design & analysis,
Stony-Brook/BNL (USA)	• Design and construction of prototype $\beta=1$ cavity(ies), • HOM damping
TEMF Darmstadt (Germany)	• Beam influence of RF power coupler,
TRIUMF (CANADA)	• Design and construction of prototype $\beta=0.65$ cavity(ies), HOM damper specifications

A first SPL collaboration meeting was held at CERN on 11-12 December 2008. A collaboration “constitution” is being made in the form of a M(emorandum) o(f) U(nderstanding to be signed by all the collaborating institutes.

The collaboration created 4 working groups:

- beam dynamics and beam loss management,
- high-power RF equipment: power distribution, circulators, loads, vector modulators,
- cryo-module and integration,
- cavity design & construction: cavity geometry, HOM damper, power coupler & manufacturers, processing, testing

At CERN a core team was formed with a project leader and responsible persons for each activity (RF, Cryomodules, Architecture, Safety, Cavities, Beam dynamics and Integration)

The working groups have common meetings via phone and video. Once or twice per year collaboration meetings are planned with representatives of all the institutes. Once per year an open meeting will be held at CERN.

A link to the SPL web site can be found here: <https://twiki.cern.ch/twiki/bin/view/SPL/SplWeb>

7. PS2

The project study for PS2 officially started in September 2006. A conceptual design report is to be produced by 2012 when a Council decision on construction is envisaged. The main parameters for PS2 have been defined, based on LHC requirements. The design study is in progress by a team at CERN. By mid 2009 the lattice design shall be frozen and the conceptual design of the components and systems can start. By mid 2009 the choices for the civil engineering shall also be made and frozen. In Figure 8 the proposed layout of the machine can be found. Figure 9 shows the optics layout of the basic arc cell. Once the machine has been defined collaborations for the construction can be formed.

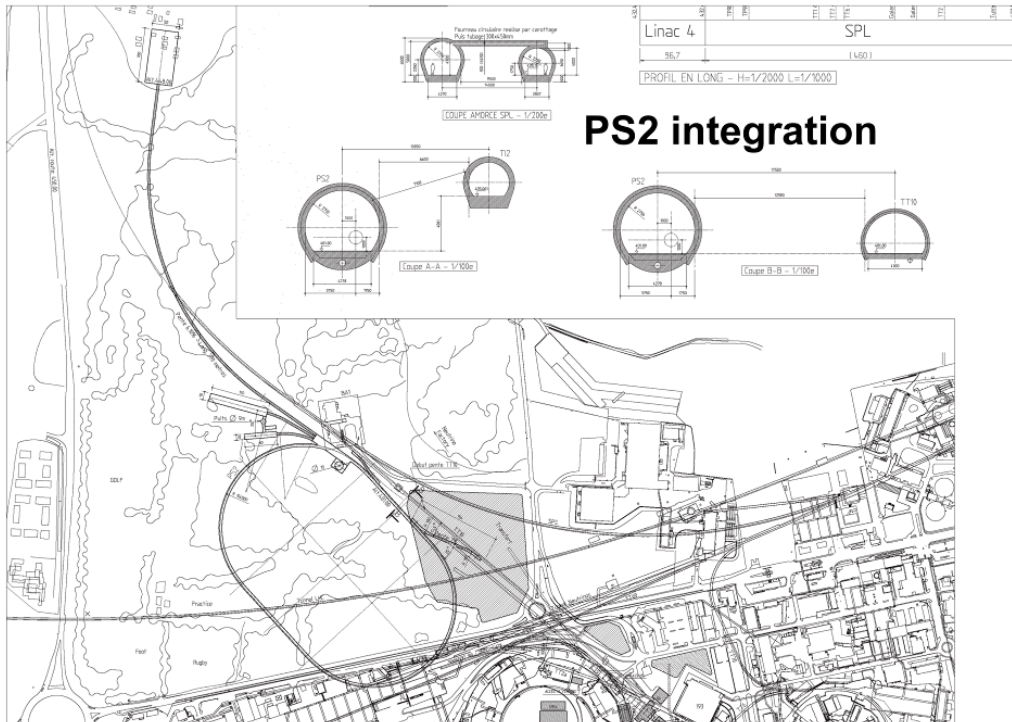

Figure 8. PS2 Layout proposal (dd 26-02-09)

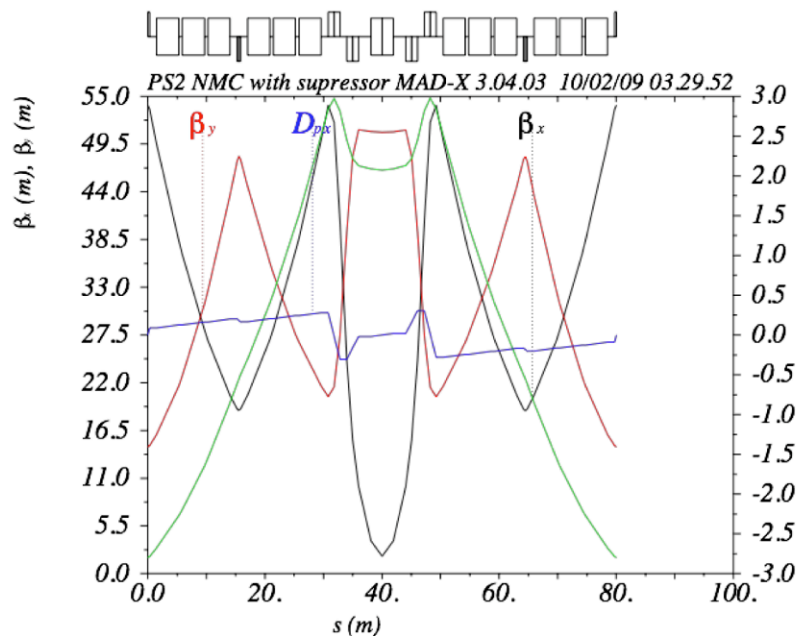

Figure 9. Arc cell layout and optics with negative momentum compaction, (dd 26-02-09)

8. SPS UPGRADE STUDIES

This study project has the aim to upgrade the SPS for high brilliance beams. It is composed of a CERN working group with strong networking in CARE-HHH and EuCARD-AccNet-EuroLumi

The SPSU Study Team exists since March 2007, with as main tasks:

- To identify limitations in the existing SPS.
- To study and propose solutions.
- To produce a design report in 2011 with a cost plan and planning.

The group holds ~12 formal meetings per year, supplemented by informal discussions and meetings. The group will produce a SPS upgrade project proposal by 2011.

The SPSU study activities in 2007-2009 are centred around:

- SPS beam dump upgrade
- MKE kickers upgrade
- SPS impedance budget, understanding and cures
- e-cloud understanding the limitations and cures

The SPSU study group has the following web page : <http://paf-spsu.web.cern.ch/paf-spsu/>

9. LUMINOSITY UPGRADE NETWORK

The study group was part of the CARE-HHH network (<http://care-hhh.web.cern.ch/care-hhh/>) and will continue in the EuCARD EuroLumi network (<https://eucard.web.cern.ch/EuCARD/>).

All aspects of the sLHC are subject to study by the EuroLumi network. The studies cover the existing sub-projects but also upgrade issues inside the LHC itself that are not (yet) a sub-project. The network is also in close contact with other programs like LARP in the US.

The network functions as a breeding ground for ideas to improve the LHC luminosity and to branch off sub-projects once sufficiently matured. Presently under study are scenarios for a Phase 2 upgrade of the LHC insertions.

Phase2 Insertion concepts under study are:

- Insertion optics
- Very large aperture, high gradient quadrupoles
- Crab cavity schemes
- Beam separation schemes with a "Dipole first" pre-separation

10. CONCLUSIONS

In the years 2007 -2008 the sLHC project was defined and started up successfully with a series of sub-projects in 3 categories: 2 sLHC construction projects, 3 sLHC project preparation studies and a sLHC luminosity upgrade network. Important target dates are:

- Phase 1 completion in the 2013-2014 shutdown.
- Phase 2 approval in 2012.
- Phase 2 implementation in 2017-2018.